



OWP326T-30-6

OIL WELL PUMP MOTOR

HIGH TORQUE / HIGH SLIP (5 - 8%)

TOTALLY ENCLOSED FAN COOLED

INVERTER DUTY 10:1 CONSTANT TORQUE - NEMA MG1 PART 31

Factory Certified for T2B Class I, Division II, Groups A,B,C & D and Class II, Division II, Groups F & G

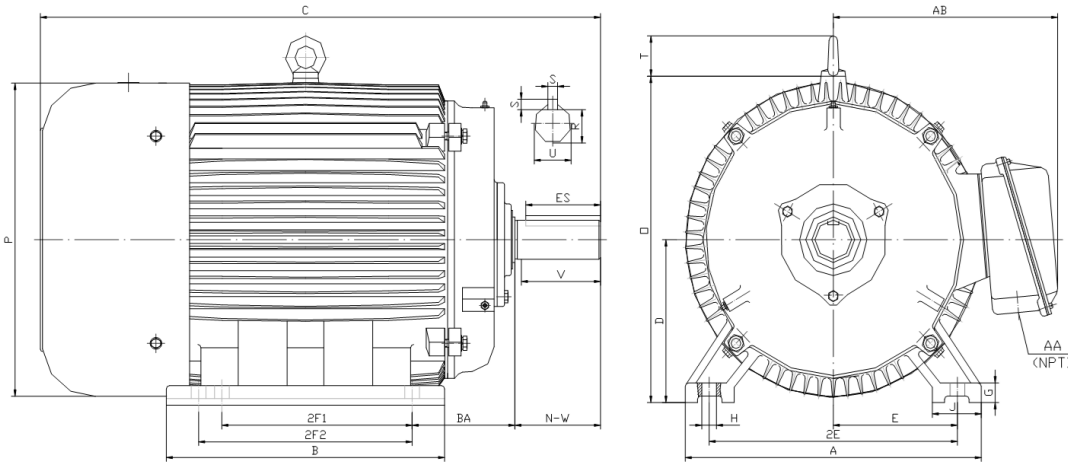

DIMENSIONS

HP	RPM	Frame	MOUNTING														
			A	B	C	D	G	H	J	E	2E	2F1	2F2	O	P	T	BA
30	1200	326T	15.50	14.70	31.30	8.00	1.00	0.66	2.75	6.25	12.50	10.50	12.00	15.90	15.70	2.60	5.25

Shaft Extension, Key Set					Conduit Box		Bearings		Mount	
U	V	R	S	ES	N-W	AA	AB	DE		ODE
2.125	5.00	1.845	0.500	3.91	5.25	2.00	12.30	6312	6312	F2

BEARING LUBRICATION: The bearings come lubricated with Mobil Polyrex EM Polyurea Grease. It is recommended that you add some additional lubrication when the motor is installed.

Three options (brands) for suitable lubrication include, but are not limited to, the following:

- 1.) Mobil Polyrex EM
- 2.) Citco Polyurea MP
- 3.) Conoco Phillips Polytac EP



Electrical Helper.org

For All Your Electric Needs Since 1928
411 N Platte Ave. York, NE. 68467

**AC-DC MOTORS :: SALES & SERVICE
REWINDING :: CUSTOM CONTROL PANEL**

Kelly MacMillan
Office Ph: 888-226-4917
Fax: 888-226-4917
Cell: 402-679-1579
E-Mail: kelly@electricalhelper.com





OWP326T-30-6

OIL WELL PUMP MOTOR

HIGH TORQUE / HIGH SLIP (5 - 8%)

TOTALLY ENCLOSED FAN COOLED

INVERTER DUTY 10:1 CONSTANT TORQUE - NEMA MG1 PART 31

Factory Certified for T2B Class I, Division II, Groups A,B,C & D and Class II, Division II, Groups F & G

PERFORMANCE DATA

HP	RPM	Frame	Voltage	Frequency (Hz)	Full Load S.F.	Insulation Class	NEMA Design	Slip (%)	NEMA Code	Enclosure Type	IP Rating	Max. Ambient
30	1130	326T	230/460/796	60	1.15	F	D	5.8	G	TEFC	55	40° C

Amps (460V)		Efficiency (%)				Power Factor			Torque (ft-lb)			DE Bearing	DE Bearing	Connection	Weight (lbs.)
FLA	LRA	100%	75%	50%	Min.	100%	75%	50%	FLT	LRT %	BDT %				
38.5	217.0	86.5	87.0	86.4	84.0	0.85	0.76	0.61	139.5	300	330	6312	6312	12 Lead 2Δ/Δ/Y	572

NAME PLATE

North American Electric, Inc.						OIL WELL PUMP MOTOR						CONNECTION DIAGRAMS									
INVERTER DUTY 10:1 CONSTANT TORQUE						NEMA DESIGN D HIGH TORQUE/HIGH SLIP (5-8%)															
CAT NO:		OWP326T-30-6		HP		30		Hz		60		PHASE		3							
VOLTS		230/460/796		FLA		38.5		IP RATING		55											
RPM		1130		POWER FACTOR		0.85		DESIGN		D											
FRAME		326T		NEMA NOM EFF		86.5		CODE		G											
DRIVE END BEARING		6312		NEMA MIN EFF		84.0		S.F.		1.15											
OPP DRIVE END BEARING		6312		MAX AMB		40° C		INS CLASS		F											
ENCL		TEFC		RATING		CONT		SER													
MOTOR WEIGHT		572 LBS		CONNECTION		12 Lead 2Δ/Δ/Y		LUB:		Mobil Polyrex EM											
Designed Specifically for use on Oil Well Pumping Units Hernando, Mississippi												CC 082A									

APPLICATIONS:

Designed Specifically for use on Oil Well Pumping Units. Suitable for use on Variable Frequency Drives (VFDs).



Electrical Helper.org

For All Your Electric Needs Since 1928

411 N Platte Ave. York, NE. 68467

**AC-DC MOTORS :: SALES & SERVICE
REWINDING :: CUSTOM CONTROL PANEL**

Kelly MacMillan

Office Ph: 888-226-4917

Fax: 888-226-4917

Cell: 402-679-1579

E-Mail: kelly@electricalhelper.com

